

This document is the property of Nian-Yeong Corporation and is delivered on the express condition that it is not to be disclosed, reproduced or used, in whole or in part, for manufacture or sale by anyone other than Nian-Yeong Corporation without its prior consent, and that no right is granted to disclose or to use any information in this document.

CUSTOMER DRAWING

REV.	DESCRIPTION	APPROVED BY	DATE	ECN NO.
A				
B				
C				

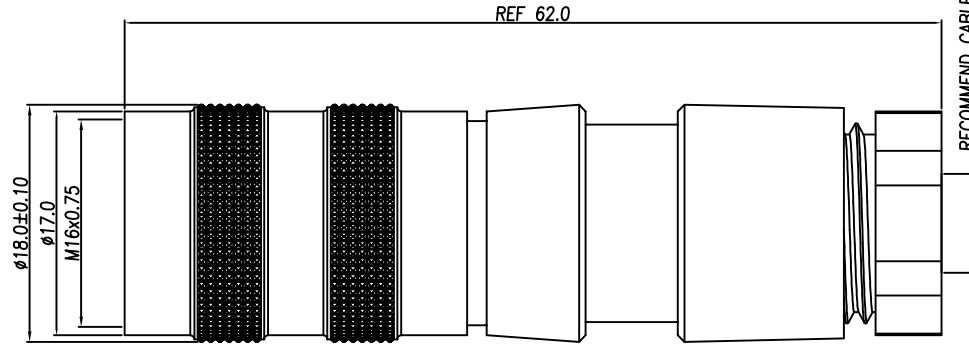
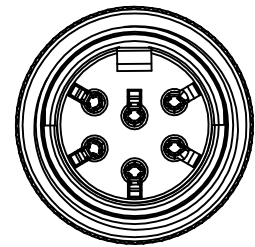

- MATERIAL :
 - 1-1. HOUSING : NYLON UL94V-0 ; COLOR : BLACK
 - 1-2. CONTACT : 3~8PIN PHOSPHOR BRONZE;12PIN BRASS
 - 1-3. ISOLATION : PVC
 - 1-4. CAP : ZINC ALLOY
 - 1-5. CLAMPS : ZINC ALLOY
 - 1-6. CLAMPS BODY : ZINC ALLOY
 - 1-7. SCREW : SPCC
 - 1-8. COAT : BRASS
 - 1-9. BACK BODY : NYLON+GF15% UL94V-0;COLOR :BLACK
 - 1-10. GLAND : SILICONE COLOR : BLACK
 - 1-11. GLAND CAGE : POM ; COLOR : WHITE
 - 1-12. GLAND NUT : NYLON UL94V-0 ; COLOR : BLACK
- FINISH :
 - 2-1. CONTACT : 3~8PIN:
 - CONTACT AREA : GOLD FLASH PLATING
 - SOLDER AREA : TIN
 - UNDER PLATE : NICKEL
 - 12PIN:
 - CONTACT : GOLD FLASH PLATED
 - 2-2. CAP: NICKEL PLATED
 - 2-3. CLAMPS : NICKEL PLATED
 - 2-4. CLAMPS BODY : NICKEL PLATED
 - 2-5. SCREW : NICKEL PLATED
 - 2-6. COAT: NICKEL PLATED
- ELECTRICAL SPECIFICATION :
 - 3-1. Rated current :3PIN~8PIN 5A ; 12PIN 3A
 - 3-2. Rated Voltage :3PIN~8PIN 250V ;12PIN 60V
 - 3-3. Water proof : IP40
- Environmental :
 - 4-1. Operation Temperature : -20 ℃~85℃

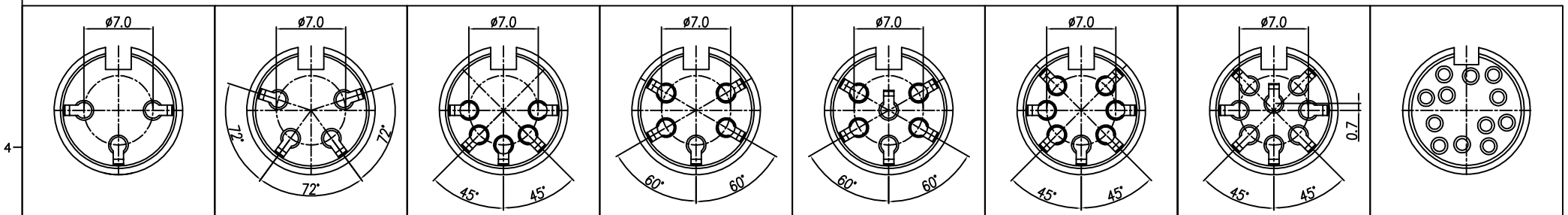

DI-03F2-14-11	DI-04F2-20-11	DI-05F2-17-11	DI-05F2-21-11	DI-06F2-25-11	DI-07F2-17-11	DI-08F2-15-11	DI-12F2-14-11
---------------	---------------	---------------	---------------	---------------	---------------	---------------	---------------

DRAWN	LED	APP'D	Ku Chou	UNIT	mm	TOLERANCE			TITLE	DIN (F) Assembly type			SHEET
CHK'D	Emily Suen			SCALE	1:1	.x ±0.20 .xx ±0.10 .xxx ±0.05 .xxxx ±0.03 ANGULA ±1°			PART NO.	SEE TABLE A	DWG NO.	QC9187	1/3
									年永實業有限公司				VERSION A

This document is the property of Nian-Yeong Corporation and is delivered on the express condition that it is not to be disclosed, reproduced or used, in whole or in part, for manufacture or sale by anyone other than Nian-Yeong Corporation without its prior consent, and that no right is granted to disclose or to use any information in this document.

CUSTOMER DRAWING

REV.	DESCRIPTION	APPROVED BY	DATE	ECN NO.
A				
B				
C				

ASSEMBLY INSTRUCTION

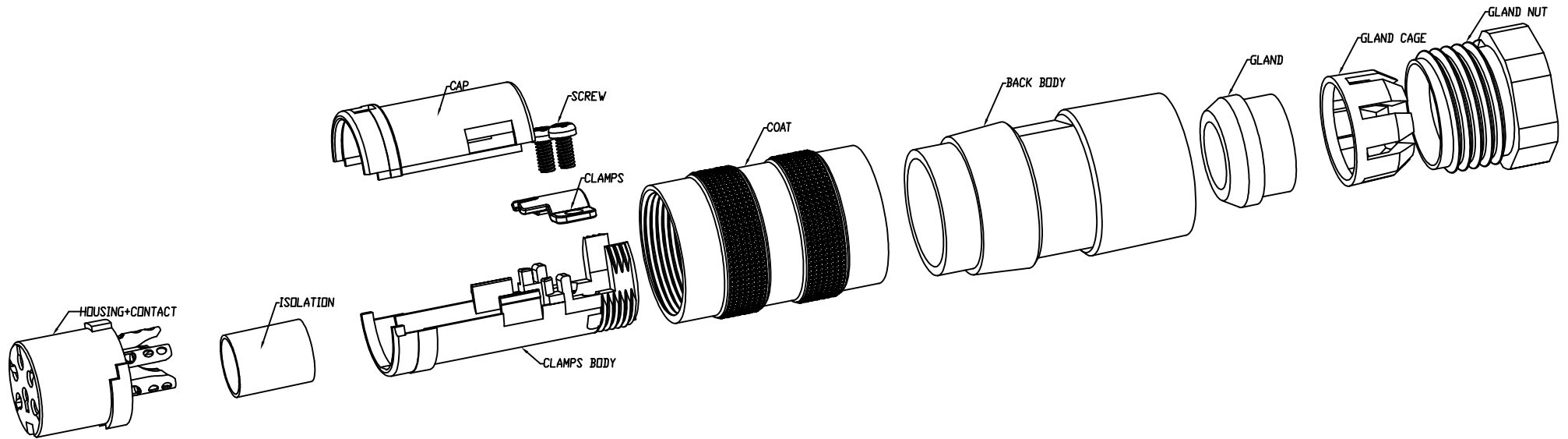

DRAWN	LED	APP'D	Ku Chou	UNIT	mm	TOLERANCE	  	TITLE	DIN (F) Assembly type			SHEET
CHK'D	Emily Suen			SCALE	1:1	.x ±0.20 .xx ±0.10 .xxx ±0.05 .xxxx ±0.03 ANGULA ±1°		PART NO.	SEE TABLE A	DWG NO.	QC9187	2 3 VERSION A

NIAN YEONG ENTERPRISE
年永實業有限公司

This document is the property of Nian-Yeong Corporation and is delivered on the express condition that it is not to be disclosed, reproduced or used, in whole or in part, for manufacture or sale by anyone other than Nian-Yeong Corporation without its prior consent, and that no right is granted to disclose or to use any information in this document.

CUSTOMER DRAWING

REV.	DESCRIPTION	APPROVED BY	DATE	ECN NO.
A				
B				
C				

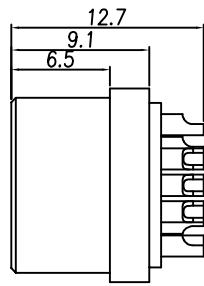
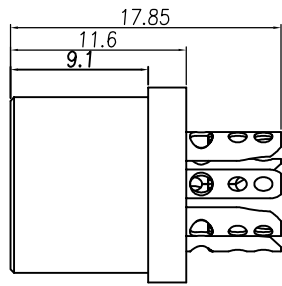
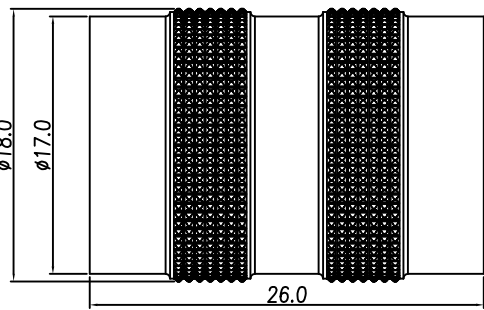
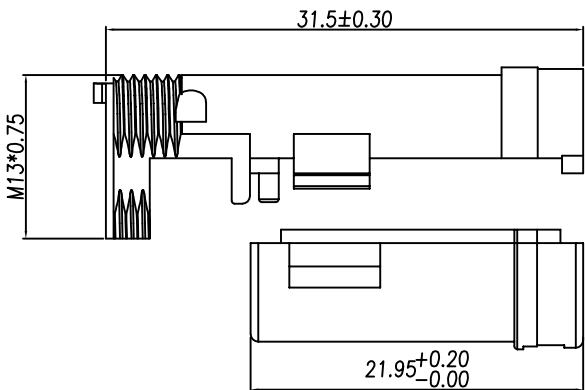

3~8 PIN尺寸

12PIN尺寸

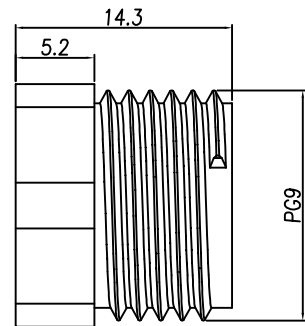
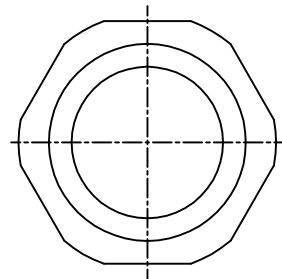
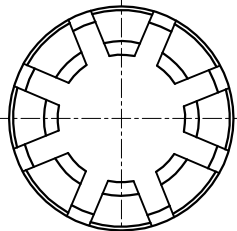
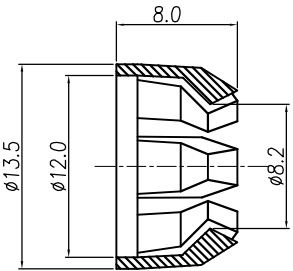
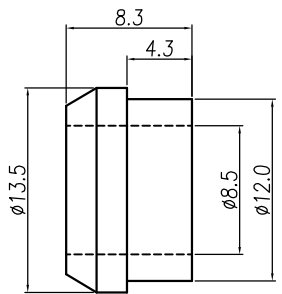
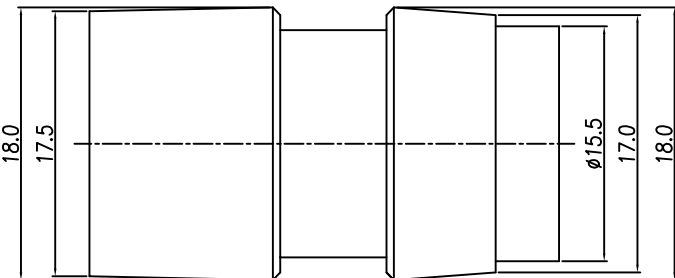
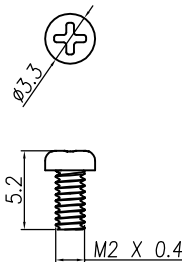
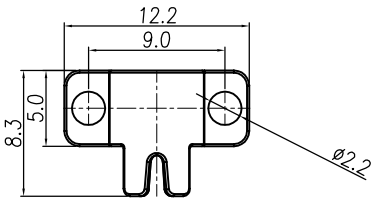
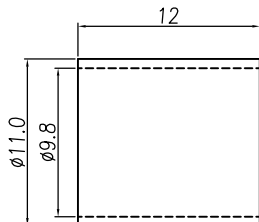

DRAWN	LED	APP'D	Ku Chou	UNIT	mm	TOLERANCE		TITLE	DIN (F) Assembly type			SHEET		
CHK'D	Emily Suen			SCALE	1:1	.x ±0.20 .xx ±0.10 .xxx ±0.05 .xxxx ±0.03 ANGULA ±1°			NIAN YEONG ENTERPRISE 年永實業有限公司	PART NO.	SEE TABLE A	DWG NO.	QC9187	3/3 VERSION A