

This document is the property of Nian-Yeong Corporation and is delivered on the express condition that it is not to be disclosed, reproduced or used, in whole or in part, for manufacture or sale by anyone other than Nian-Yeong Corporation without its prior consent, and that no right is granted to disclose or to use any information in this document.

CUSTOMER DRAWING

| REV. | DESCRIPTION | APPROVED BY | DATE | ECN NO. |
|------|----------------------|-------------|-----------|---------|
| A | RELEASE | Ku Chou | 30/11/18* | |
| B | CHANGE RATED VOLTAGE | Ku Chou | 13/12/18* | |
| C | | | | |

TABLE A

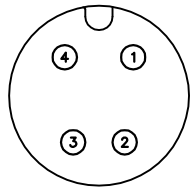

WP-04F2-206-11

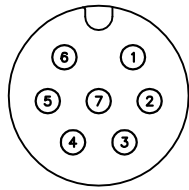

WP-07F2-13-11

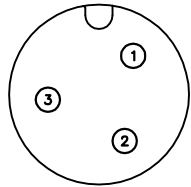

3P

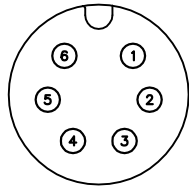

6P

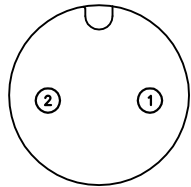

2P

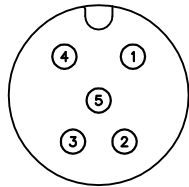

WP-05F2-161-11

Pin Assignments
Front View

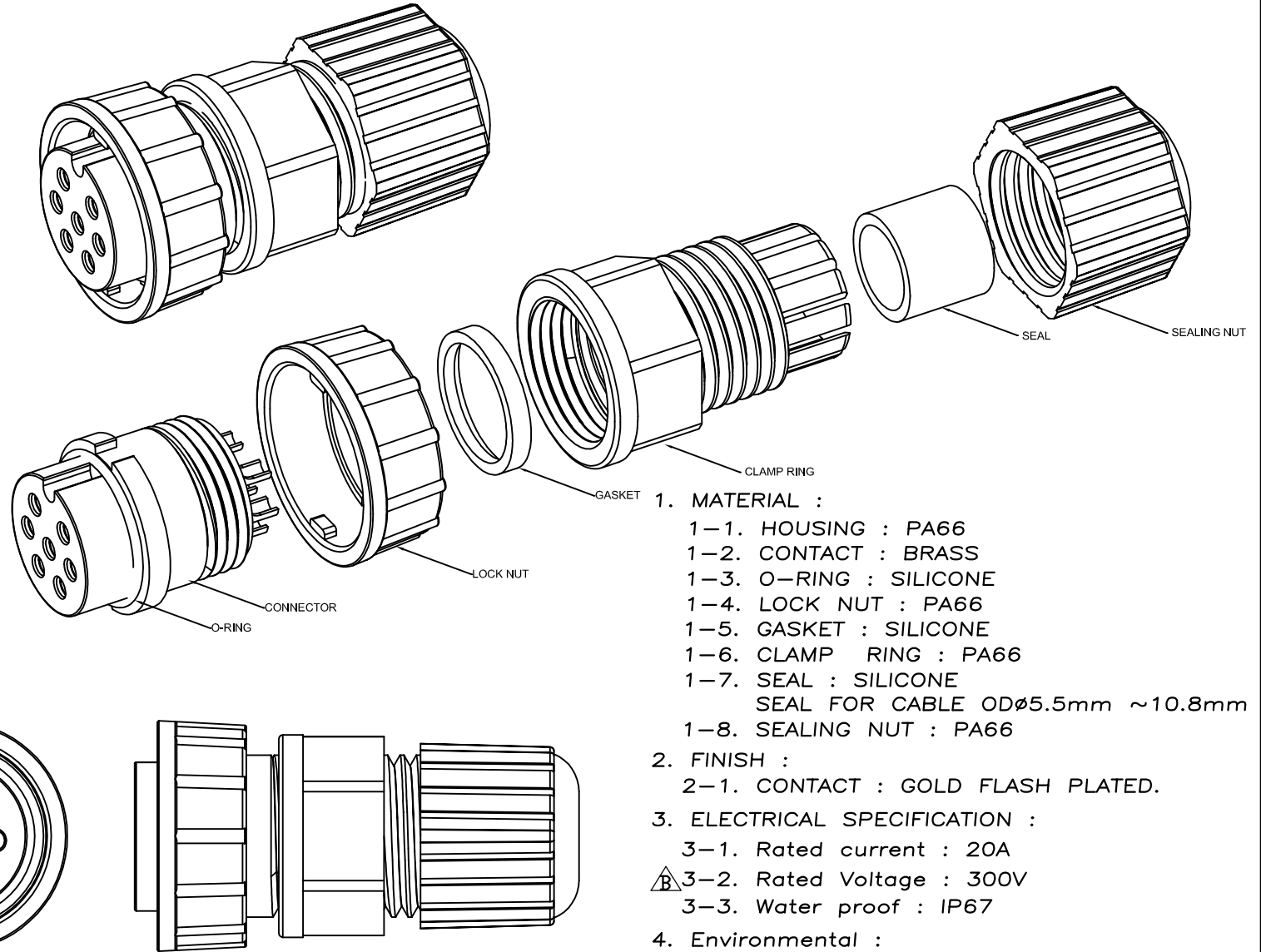
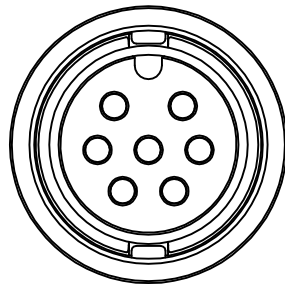

1. MATERIAL :

- 1-1. HOUSING : PA66
- 1-2. CONTACT : BRASS
- 1-3. O-RING : SILICONE
- 1-4. LOCK NUT : PA66
- 1-5. GASKET : SILICONE
- 1-6. CLAMP RING : PA66
- 1-7. SEAL : SILICONE
SEAL FOR CABLE OD ϕ 5.5mm ~10.8mm
- 1-8. SEALING NUT : PA66

2. FINISH :

- 2-1. CONTACT : GOLD FLASH PLATED.

3. ELECTRICAL SPECIFICATION :

- 3-1. Rated current : 20A
- 3-2. Rated Voltage : 300V
- 3-3. Water proof : IP67

4. Environmental :

- 4-1. Operation Temperature : -40 $^{\circ}$ C~105 $^{\circ}$ C

| | | | | | | | | | | | | | |
|-------|------------|-------|---------|---------|-----------------|-----------|--|--|-------------|---|--------|---------|-------|
| DRAWN | Emily Suen | APP'D | Ku Chou | UNIT | mm | TOLERANCE | | | TITLE | WP FEMALE (FEMALE PIN) D SIZE ASSEMBLY TYPE(LOCK)-20A | | | SHEET |
| CHK'D | Ku Chou | SCALE | 1:1 | ANGULAR | $\pm 1^{\circ}$ | PART NO. | | | SEE TABLE A | DWG NO. | QC8836 | VERSION | B |

NIAN YEONG ENTERPRISE
年永實業有限公司